

IRON PLANT

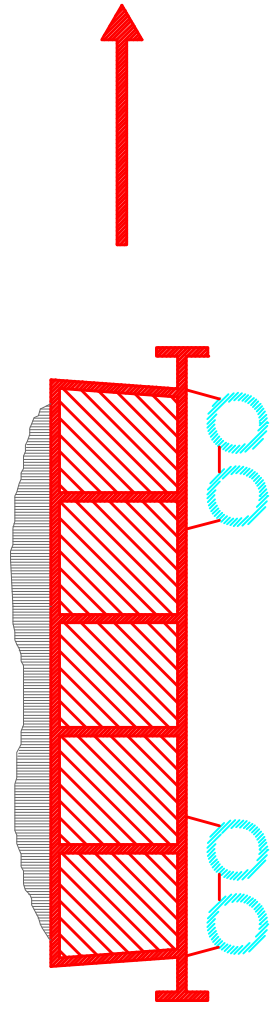
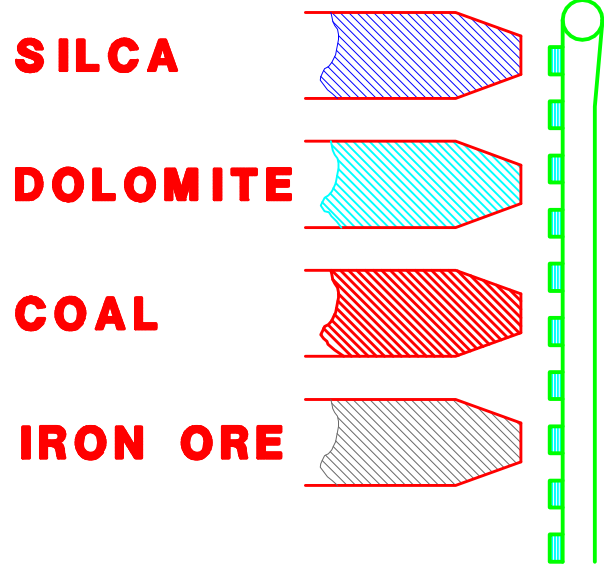

INCOMING RAW MATERIAL

- 10 plus 3 LURGI KILNS 61m x 4m
- 10 plus 3 LURGI PRECIPITATORS
- POST COMBUSTION TOWERS
- CONDITIONING TOWERS

MATERIALS STORAGE
BUNKERS AND KILN
FEED PROPORTIONING
EQUIPMENT.

ROTARY KILN

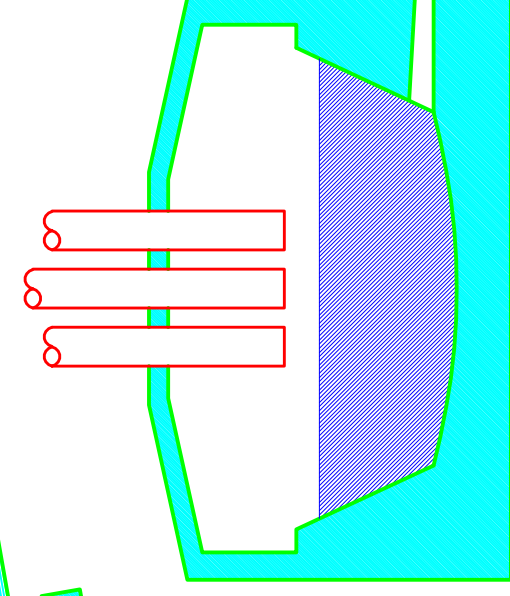
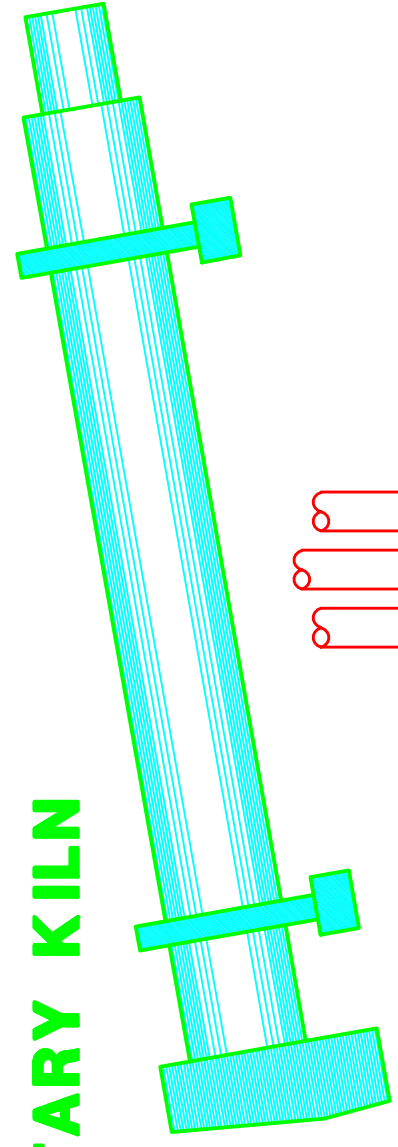

ELECTRIC SMELTER

- 3 x 33 MVA ELKEM FURNACES
- 3 x 45 MVA ELKEM FURNACES
- 1 x 63 MVA DEMAG FURNACE
- VENTURIES
- VENTURIES
- DISINTEGRATORS

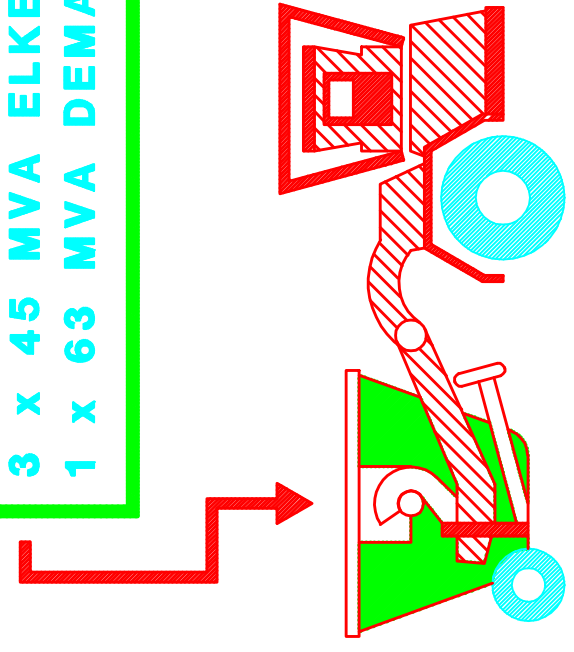

WASTE SLAG

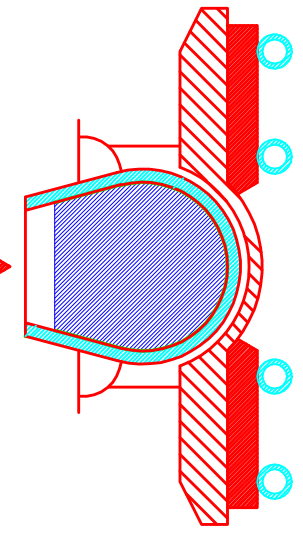
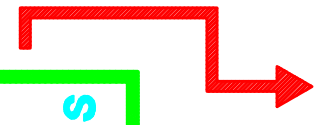

IRON TO STEEL PLANT